

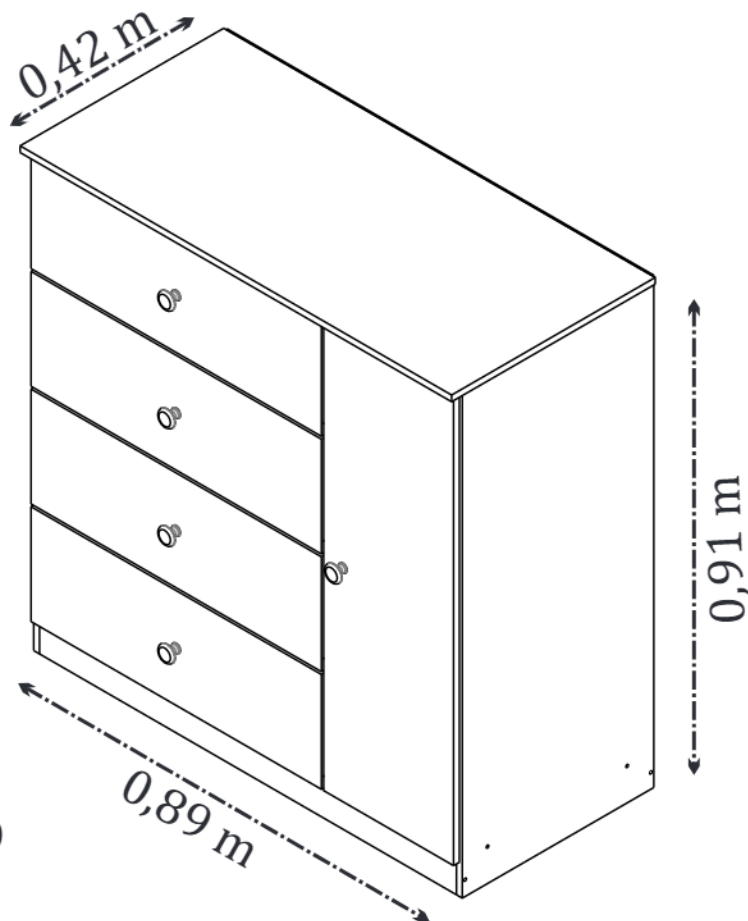

Qualidade para merecer você

MANUAL DE MONTAGEM - CÔMODA 4 GAVETAS AFETO



CÔMODA 4 GAVETAS AFETO CÓD. 25824

O fabricante se reserva ao direito de introduzir modificações técnicas em seus produtos, sem aviso prévio e sempre que julgar conveniente.

NECESSÁRIO:



Chave Philips



Martelo



Pessoa
necessária



Recomendamos que a montagem seja feita por um profissional capacitado.

Tcil Móveis LTDA
CNPJ 38.542.932/0001 39
Rodovia Ubá - Guidoal, s/n°Km 01
CEP- 36500-970





















IMPORTANTE: Antes da montagem deste produto, confira todo conteúdo de peças e componentes conforme indicado abaixo. No caso de falta de peças, entre imediatamente em contato com a loja onde o mesmo foi comprado para resolução do problema. A não observância desta instrução, exime o fabricante de quaisquer responsabilidades futuras.

LISTAGEM DE PEÇAS CÔMODA 4 GAVETAS AFETO

MEDIDAS EM mm

CÓDIGO DA PEÇA	QUANT.	DESCRIÇÃO	COMPRIMENTO	LARGURA	PROFUNDIDADE	TIPO DE MATERIAL
20004	1	LATERAL DIREITA	900	395	12	MDP 12 MM
20005	1	LATERAL ESQUERDA	900	395	12	MDP 12 MM
20006	1	DIVISÃO	840	395	12	MDP 12 MM
20007	1	TAMPO	890	420	12	MDP 12 MM
20008	1	BASE	395	258	12	MDP 12 MM
25826	1	PORTA	835	268	12	MDP 12 MM
20010	4	FRENTE GAVETA	599	205	12	MDP 12 MM
12990	8	LATERAL GAVETA	350	110	12	MDP 12 MM
19451	4	TRASEIRO GAVETA	546	95	12	MDP 12 MM
19452	4	FUNDO GAVETA	556	350	2,5	MDF 2,5 MM
20011	3	COSTA	879	285	2,5	MDF 2,5 MM
20012	1	RODAPÉ FRONTAL	860	60	12	MDP 12 MM
20013	1	RODAPÉ TRASEIRO	860	60	12	MDP 12 MM
19670	1	TRAVESSA	371	60	12	MDP 12 MM

LISTAGEM DE FERRAGENS

Cód: 2471 (x30)  CAVILHA MADEIRA 6X25	Cód: 2466 (x8)  CANTONEIRA METAL 4 FUROS	Cód: 2505 (x12)  PARAFUSO CABEÇA CHATA 3,5x40	Cód: 2457 (x2)  CALÇO DOBRADIÇA 26MM Nº 5	Cód: 2481 (x2)  DOBRADIÇA CURVA 26 MM	Cód: 10649 (x84)  PARAFUSO CABEÇA CHATA 3,5x10
Cód: 2677 (x1)  GIZ CERA	Cód: 2520 (x5)  PARAFUSO FLANGEADO 3,5x25	Cód: 11063 (x6)  SAPATA L 1 FURO	Cód: 2521 (x6)  PARAFUSO FLANGEADO 3,5x40	Cód: 7239 (x50)  PREGO C/CABEÇA 8x8	Cód: 20100 (x2)  PERFIL H 25X17 PLÁSTICO 879mm
Cód: 12367 (x2)  APOIO DOBRADIÇA	Cód: 19501 (x4)  CORREDORA TELESCÓPICA 1 ESTÁGIO 350MM	Cód: 20095 (x1)  CABIDEIRO ALUMÍNIO 248MM	Cód: 2576 (x2)  SUPORTE CABIDEIRO 30X16	Cód: 10101 (x8)  CONECTOR PLÁSTICO 4 FUROS	Cód: 21200 (x40)  PARAFUSO FLANGEADO 3,5x12
Cód: 9052 (x8)  SUPORTE TRIANGULAR C/ ABA	Cód: 19456 (x5)  PUXADOR GRACE	Cód: 14025 (x1)  ETIQUETA TILILIN			

